











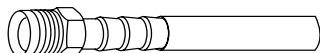









SPECIAL SERVICE ITEMS

LIFE	
	<p>Transmission Prep Assembly (16 oz. Tub)</p> <p>Lube - 96-304</p> <p>Synthetic Lube - 96-304A</p>
	<p>Trans Flush</p> <p>(18 oz. Can) - 96-306 (14 oz. Can) - 96-306S</p> <p>To Flush Transmission Coolers & Lines</p>
	<p>96-306F 96-306K (Kit)</p> <p>3/8" Fitting w/Hose (For 96-306)</p>
	<p>96-307</p> <p>Life Strips (Packaged in 10's)</p> <p>Transmission Temperature Recorders</p>
	<p>96-311</p> <p>Synthetic Trans Flush (White Bottle - 10 oz)</p> <p>Cleans & Prepares transmission for new ATF</p>
	<p>96-312</p> <p>Trans Prep III (Spray Cans Sold Individually ONLY)</p>
	<p>Smart Blend</p> <p>96-313 Synthetic ATF Protectant (Red bottle - 10 oz)</p> <hr/> <p>96-313A Synthetic HFM Supplement (Black Bottle - 10 oz)</p> <hr/> <p>96-313B M-V Supplement (Blue Bottle - 10 oz)</p> <hr/> <p>96-313C Titanium Supplement (Silver Bottle - 10 oz)</p>

LIFE	
	<p>96-313K</p> <p>Smart Blend Flush Package Red/White (2-10 oz. Bottles)</p>
	<p>96-314</p> <p>Tru-Volt (10 oz. Can)</p>
	<p>96-316</p> <p>Sure Grip Clear (12 oz. Can)</p>
	<p>96-332</p> <p>Shudder Eliminator (2 oz. Tube)</p>
	<p>96-333</p> <p>Gear Fluid Supplement (10 oz. Bottle)</p>

SPECIAL SERVICE ITEMS

LUBEGARD	
	<p>Assemblee Goo (16 oz. Tub)</p> <p>96-156L - (Green) 96-156LB - (Blue)</p>
	<p>96-309 Kooler Kleen (13 oz. Can)</p>
	<p>96-318 Free-eze (15 oz. Bottle)</p>
	<p>96-319 Dr. Tranny Instant Shudder Fixx (10 oz. Tube)</p>
	<p>96-320 All Purpose Lube (4 oz. Each - Sold Individually Only)</p>
	<p>96-321 Bio-Tech Engine Protectant (15 oz. Bottle)</p> <p>96-309B Bio-Tech Engine Flush (15 oz. Bottle)</p> <p>96-321K Bio-Tech - Twin Pack (2 - 15 oz. Bottles)</p>

LUBEGARD	
	<p>96-322 Limited Slip Fluid Supplement (4 oz. Bottle)</p> <p>For Use With All Limited Slip Differentials</p>
	<p>Lubegard Power Steering 96-323 - Fluid (10 oz. Bottle) 96-323B - Supplement (4 oz. Bottle) 96-323K - Twin Pack (2 - Bottles)</p>
	<p>96-324 Lubegard Gear Fluid Supplement w/LXE (8 oz. Bottle)</p>
	<p>Transmission Fluid Supplements ATF Protectant 96-325 (10 oz. Red Bottle) All Exc. Chrysler, Honda, Toyota</p> <p>96-325-5 (5 Gallon Pail) All Exc. Chrysler, Honda, Toyota</p>
	<p>HFM-ATF Protectant 96-325A (10 oz. Black Bottle) Chrysler, Honda, Toyota</p>
	<p>M-V 96-325B (10 oz. Black & Green Bottle) Mercon V for Ford</p>
	<p>Lubegard Platinum 96-325C (10 oz. Bottle) Universal ATF Protectant</p>
	<p>Automatic Transmission Flush 96-309A (10 oz. Bottle)</p>
	<p>Flush & Protect Performance Packs (2 - 10oz. Bottles)</p> <p>96-325K ATF Protectant 96-325AK HFM-ATF Protectant 96-325BK M-V 96-325CK Platinum</p>

SERVICE ITEMS

SPECIAL SERVICE ITEMS

LUBEGARD



96-326 (16 oz. Bottle)
96-326-1 (1 Gallon)
Lubegard Valve & Assembly Lube



96-334
Lubegard Brake Squeak Relief
 (11 oz. Bottle)



KOOL-IT
96-336 (16 oz. Bottle)
Supreme Coolant Treatment
96-336A
Cooler Flush (16 oz. Bottle)
96-336K
Flush & Protect Performance Pack
 (2 - 16 oz. Bottles)



96-340
Lubegard Assembly Treatment
 (8 oz. Bottle)

MUSCLE



96-300
MT-10 Muscle Metal Treatment - 8 oz.
 (Sold Individually)



96-301
STAR LUBE™
Transmission Assembly Spray Lube
 (16 fl. oz. In A Trigger Sprayer)
 Cleans, Conditions, Lubricates
 and Protects.

SPX



96-156G
 (1 lb. Tubs)
Gold
Transmission Assembly Lube
 (Sealed Power Brand)

SONNAX



96-156S
Slippery Stick
 Sonnax Lube Stick

TRANSTAR



96-151
Silicone RTV Sealant
3.0 fl. oz. Tube
 (Sold 12 per case ONLY)



96-152
Silicone RTV Sealant
10.1 fl. oz. Cartridge
 (Sold individually ONLY)



96-9103
100% Pure Silicone Lubricant
 (10.25 oz. Can
 Sold Individually and 12/Case)



96-9113
Carb & Choke Cleaner
 (12 oz. Can
 Sold Individually and 12/Case)



96-9133
White Grease
 (11 oz. Can
 Sold Individually and 12/Case)



96-9143
4-Way Penetrant
 (11.75 oz. Can
 Sold Individually and 12/Case)



96-9173
96-9173C (California Compliant)
Non-Chlorinated Brake Cleaner & Degreaser
 (12 oz. Can - Sold Individually and 12/Case)

LOCTITE



For over fifty years, Loctite products have been reliably solving automotive maintenance and repair needs. When you buy Loctite products you're getting the same product that vehicle manufacturers use in production. Why use anything else?

SEALANTS

96-360C	High Performance RTV Black	(In Pressurized Can)	9 oz. can
96-361	High Temperture RTV Red		80 ml. tube
96-362	Case to Case Gasket Maker 518	(Use w/o Gasket)	50 ml. tube
96-364	High-Tac Gasket Coating	(Use w/Gasket)	16 oz. can

THREAD/BEARING LOCKER

96-365	Bearing Mount (Locker) 609	(Retains bushings/sleeves/etc.)	36 ml. bottle
96-366	Threadlocker Blue 242 Medium Strength		36 ml. bottle
96-366E	Threadlocker Blue 242 Medium Strength	(Lipstick Applicator)	19 g. stick
96-367	Threadlocker Red 271 High Strength		36 ml. bottle
96-367E	Threadlocker Red 271 High Strength	(Lipstick Applicator)	19 g. stick

THREAD DRESSING

96-369	Thread Sealant 565 White		50 ml. tube
96-369E	Thread Sealant 565 White	(Lipstick Applicator)	19 g. stick
96-370	Form-A-Thread	(For Thread Repair)	4.8 ml. syringe







ANTI-SEIZE

96-374	Anti-Seize/Lubricant Copper	(Loosen/Prevents Rusted Threads)	1 lb. can
96-374E	Anti-Seize/Lubricant Copper	(Lipstick applicator)	20 g. stick

ADHESIVE

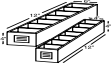
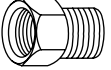
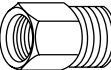
96-372	Quick Gel Adhesive (thick, not runny)	(Bonds various materials)	2 g. tube
---------------	---------------------------------------	---------------------------	-----------

SPECIAL SERVICE ITEMS

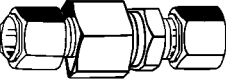
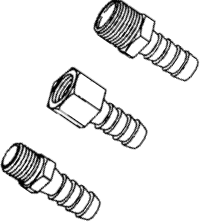
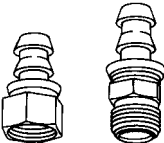
COOLER LINE COMPONENTS	
	Compression Fittings 96-100 (5/16") 96-101 (3/8")
	Inverted Flare Nut 96-129 (5/16" Line) 96-130 (3/8" Line)
	Flared Line Case Fittings 96-132 (5/16" Line x 1/4" Pipe)
	96-132A (5/16" Line x 1/8" Pipe)
	96-132B (3/8" Line x 1/4" Pipe)
	96-132C (3/8" Line x 3/8" Pipe)
	Compression Fitting 96-136 (5/16" Line x 1/4" Pipe)
	Steel Lines w/Flare Fitting 96-145 (5/16" -30") 96-145A (3/8" -30") 96-146 (5/16" -60") 96-146A (3/8" -60")
	Copper Tubing 96-148 (5/16" - 25 FT) 96-149 (3/8" - 25 FT) 96-193 (5/16" - 50 FT)
	Compression Fitting w/Anti Drainback 96-200C (5/16") 96-200D (3/8") To Eliminate Torque Converter Drainback Thru Cooler Lines. Use On Any 5/16" (96-200C) or 3/8" (96-200D) Cooler Lines.
	Transmission Cooler Line Fitting Kit 96-389 Contains: 1/4" Male Pipe x 3/8" Hose Barb 1/4" Female Pipe x 3/8" Hose Barb 3/8" Male Pipe x 3/8" Hose Barb 12" Teflon Pipe Thread Ford - Mercury - Lincoln Instructions Included
	Transmission Cooler Line Fitting Kit 96-390 Contains: 5/8" -18 Inverted Male Fitting 5/8" -18 Inverted Female Fitting 91-Up GM FWD, 87 & Earlier Jeeps w/5/8" Inverted Male Flare Fittings Instructions Included

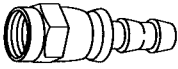
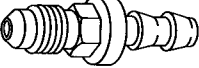
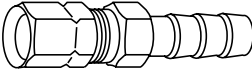
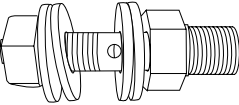
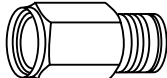
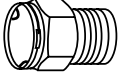
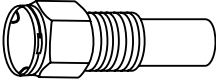
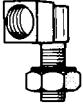
COOLER LINE COMPONENTS (Cont.)	
	Transmission Cooler Line Fitting Kit 96-391 Contains: 5/8" -18 SAE Male Fitting 5/8" -18 SAE Female Fitting 88-Up Jeeps w/ 5/8"-45° Female Flare SAE Fitting Instructions Included
	Transmission Cooler Line Fitting Kit 96-392 Contains: (2) 3/8" Hose Menders (2) 3/8" Hose Clamps 87-Up Jeeps Using Rubber Hose, w/Quick Disconnect At Radiator. Instructions Included
	Compression Fittings w/ Hose Barb 96-393 (3/8" Line) 96-394 (5/16" Line)
	Cooler Flushing Fitting 96-395 Quick, easy hook-up. Can be used with large flusher or aerosol cans with adapter. Fits most sizes of cooler line Banjo fittings.
— GENERAL MOTORS —	
	Case Fitting w/Ball 96-441 4T60 83-Up (24207294) 96-440 4T60E 91-98 (24202550) 96-440B 4T60E/65E (push-in) 98-Up (24213958)
	Push-In Case Fitting w/o Ball 96-460 (5/16" Line x 1/4" Pipe) 4L60E, 93-Up 4L80E, 97-Up (front) 4T60E/65E, 98-Up
	Rear Case Fitting 96-480 Push In (5/16" Line x 1/4" Pipe) 4L80E, 97-Up
— FORD —	
	90° Elbow 96-110 (5/16" Line, 1/8" Pipe)

SPECIAL SERVICE ITEMS

COOLER LINE COMPONENTS (Cont.)

— FORD (Cont.) —

Cooler Line Fittings

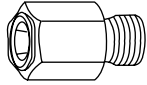

96-208 Push In (5/16" Line x 1/4" Pipe)

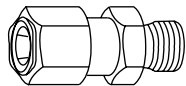

96-208A Push In (5/16" Line x 1/4" Pipe)
Clip Design

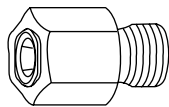

96-208B Push In (5/16" Line x 3/8" Pipe)

Flared Line Case Fitting w/Anti Drain Back Ball

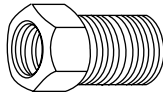

96-396 (5/16" Line x 3/8" Pipe)

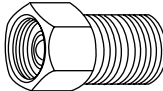

96-396A (3/8" Line x 3/8" Pipe)

To Eliminate Torque Converter Drainback
Thru Cooler Lines. Use On Any 5/16"
(96-396) or 3/8" (96-396A) Cooler Lines.

Case Fitting

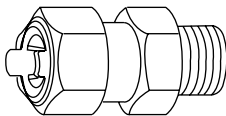

96-462 Push In (3/8" Line x 1/4" Pipe)
Clip Design

— CHRYSLER —

Male Connector



96-117 (5/16" Line x 1/8" Pipe)
96-117A (3/8" Line X 1/4" Pipe)

Flared Line Nut



96-147 (5/16" x 5/16")
96-147A (3/8" X 3/8")

Case Cooler Fittings

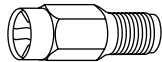

96-518 Push In (3/8" Line x 1/4" Pipe)

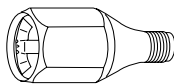

96-518B Push In (1/2" Line x 1/4" Pipe)

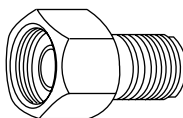

96-518C Flared (1/2" Line x 1/4" Pipe)

MISCELLANEOUS



96-102
Converter Plug (1/8")
Allen Head



96-105 (1/4")
96-106 (3/16")
Plastic Vacuum Tees



96-111 (1/4" Shaft)
96-153 (3/16" Shaft)
E Clips



96-112
GM Linkage Grommet (White)



96-114
Chrysler Linkage Grommet



96-116
Upper & Lower Rod Grommet
TF6 & TF8

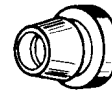

96-125
Grommet - All Large
Ford C4 & C6



96-126
Plastic Bushing
All Small Ford



96-127 (1-13/16" - GM)
96-128 (3/4" - Chrysler)
Hitch Pins



96-133
Converter Plug
Hex Head - 1/8"

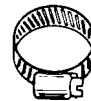

96-135A (5/16" x 1/2")
96-135 (7/32" x 7/8")
ID Range
Clamps



96-138 (3/16" x 1/8")
Modulator Hose Barb

SPECIAL SERVICE ITEMS

MISCELLANEOUS (Cont.)

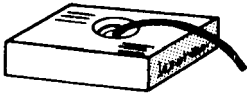

- H225** (5/16" ID - 25 FT)
- H325** (3/8" ID - 25 FT)
- H105** (11/32" ID - 5 FT)
- H125** (11/32" ID - 25 FT)
- H150** (11/32" ID - 50 FT)
- H525** (1/2" ID - 25 FT)

Hydraulic Line Hose

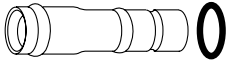

96-140A
Quick Fix Filler Tube

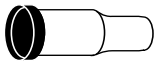

96-140B
Dip Stick Repair Tube - Boot Type

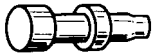

96-141
Case Vent Tube
TH350



D61141
Case Vent Tube
TH400, TH700-R4

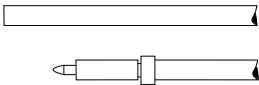

96-150
Select A Pin Package
(Contains 10 Pins And 1 Gauge)



- 96-131** (3/8" - 24T - Fine - Self Locking - C4)
- 96-160** (3/8" - 24T - Fine - w/Flange - C4)
- 96-163N** (3/8" - 16T - Coarse - Self Locking - GM)
- 96-160M** (10mm x 1mm - Metric)

Converter Nuts



- 96-161** (5/16" x 7/16" - 24T - Fine - TF6 & TF8 Converter)
- 96-163B** (3/8" x 9/16" - 24T - Fine - Standard Bolt)
- 96-164** (3/8" x 1/2" - 16T - Coarse - GM Converter)
- 96-178** (10 x 14.295 - 1.5T - Coarse - Metric - GM Converter)
- 96-177** (01-Up - Double Hex - GM Converter - 11589040)
- 96-175** (96-Up - Torx - GM Bellhousing to Case - 24203265)
- 96-604** (A604 Chrysler Converter Bolt - 4 Required)

Converter Bolt / Pan Bolt



96-180
Yellow Marker - 2 oz.
(Sold Individually)

MISCELLANEOUS (Cont.)



- 96-189** Machine Gray
- 96-190** Chevy Blue
- 96-191** Aluminum
- 96-192** Gold
- 96-194** Black

Transmission & Engine Enamel
(12 Per Case - Sold In Case Lots Only)

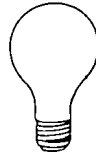

5000 Hour
Brass Base
130 Volt
AMERICAN MADE

- 96-195** (50 Watt - Frost - Regular Rough Service)
- 96-195C** (50 Watt - Tuffskin Coated - Shatterproof)
- 96-196** (75 Watt - Frost - Regular Rough Service)
- 96-197** (100 Watt - Frost - Regular Rough Service)
- 96-198** (75 Watt - Tuffskin Coated - Shatterproof)
- 96-199** (100 Watt - Tuffskin Coated - Shatterproof)

Rough Service Bulbs - Special Filament
(96-195, 196, 197 - Sold 12 Per Case ONLY)
(96-195C, 198, 199 - Sold 6 Per Case ONLY)

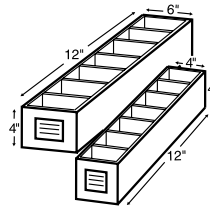

- 96-204** (4" x 4" x 12")
- 96-206** (4" x 6" x 12")

Bin Boxes
(4 Dividers Included)



96-209 (Narrow Groove)
96-209A (Wide Groove)
TV & Passing Gear Rod Grommet
FIOD & ATX

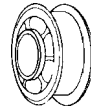

96-212
Shift Linkage Bushing
TH325/325-4L

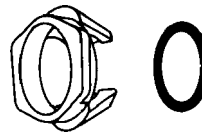

Contains Line Retaining Clip & O-Ring

96-213K
Ford Cooler Line O-Ring & Clip Kit
(Kit Also Contained In T-9130)
(Sold 10 Per Package)

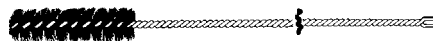

- 96-225** (5/8")
- 96-226** (7/8")
- 96-227** (1-1/8")
- 96-228** (1-3/8")

Valve Body Cleaning Brushes
(Sold Separately and as a Kit,
Part No. **K228**)

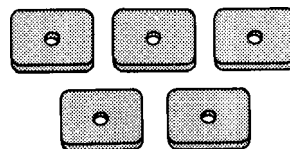

96-235
Universal Magnet
(Sold Individually and as a kit of
5 pieces, Part No. **K235**)

MISCELLANEOUS (Cont.)

Thread Insert Repair Kits

Kit Part #	Size	Insert Part #	Std. Pkg.*
COARSE THREAD			
K215C	1/4" x 20	96-215C	25
K216C	5/16" x 18	96-216C	25
K217C	3/8" x 16	96-217C	25
K218C	7/16" x 14	96-218C	25
METRIC			
K250M	6mm x 1.00mm Pitch	96-250M	25
K251M	8mm x 1.25mm Pitch	96-251M	25
K252M	10mm x 1.50mm Pitch	96-252M	25

Kits Are Packaged In A Top Quality Steel Tool Box And Contain:

- A High Quality, Easy-To-Use Hand Tap
- An Insertion Tool
- 10 Inserts*
- Complete Instructions

(* All Inserts Are Available In Minimum Packages Of 25 Each.)



1) Drill To Clear Out The Damaged Thread

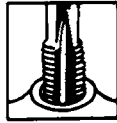

2) Thread Insert Tap

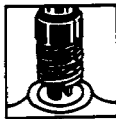

3) Install Insert

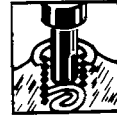

4) Remove Insertion Tang



96-303 Black
96-303A Green
GM Grommet - Oval



96-308
8" Plastic Cable Ties
(Minimum Package of 25)



96-315S
CRA-Z Soap
(1 Carton of 12, 10.7 oz. Bars)

96-315D
CRA-Z Soap Dispenser



96-315K
CRA-Z Soap Dispenser
w/12, 10.7 oz. Bars

MISCELLANEOUS (Cont.)

96-327

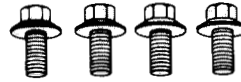

Mitsubishi Filter Bolts
(4 Per Package)

Use w/63800E - 87-Up - KM171 Series

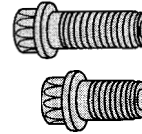

96-328 (GM 4L80E)
96-328A (GM TH400)

Center Support Bolts
(Sold 1 Per Package)



96-328B (GM 4L80E)

4th Housing Bolt
(Sold 1 Per Package)

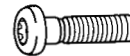

96-329
Stator Cover Bolt
700-R4

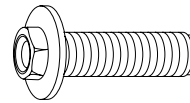

96-330
Center Support Bolt - Long
E40D

96-330A
Intermediate & Overdrive
Housing Bolt - Short
E40D

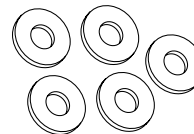

96-331
Shift Shaft Spacers
WG1356
(Available in Packages of 5 Only)



96-350VB
Valve Body Plate Ball Seat
Repair Package

1/4" Ball Package Includes 5 Seats & Clips.
Fits And Repairs 75% Of All Valve Bodies.
GM - Ford - Chrysler - Imports

Instructions Included

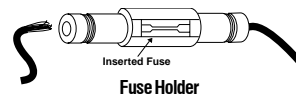

96-500H
Posi-Lock Fuse Holder
(For 12 to 18 Gauge)

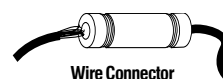

96-500P
Posi-Lock Wire Connector

96-500TK
Posi-Lock Survivor Kit
(Posi-Lock Assortment Box)

SPECIAL SERVICE ITEMS

MISCELLANEOUS (Cont.)



96-604
Torque Converter Bolts
 A604 Chrysler - 90-Up



35176 (Approx. 15" Long)
35176A (Approx. 42" Long)

Ground Straps

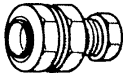

DP-1
Drain Plug Kit



96-185
Drain Plug
 5R55N/W
 00-Up

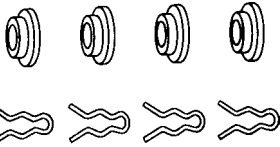

K96-209B
**TV Passing Gear Rod Grommet/
 Clip Package**
 (4 Pieces Each Grommet & Clip)
 AOD/ATX

MISCELLANEOUS (Cont.)

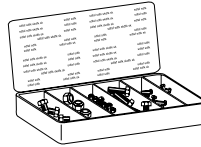

KB-120
Converter Nut & Bolt Assortment
 120 Pieces - 6 Different Numbers
 (Also Available Separately)

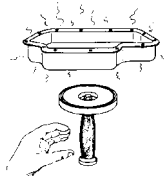

T-9125
Pan Handler (Magnetic Tool)
 Saves Time, Eliminates Use Of Rags
 Or Gloves, Collects Pan Metal
 Shavings. Many Other Uses.
No More Burnt Fingers or Hands!

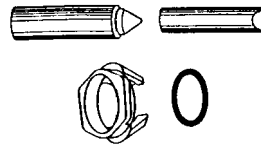

T-9130
**Ford Cooler Line
 O-Ring Installation Tool Kit**
 (Includes 2 O-Rings &
 Retaining Clips [96-213K])
 Complete Instructions Included



96-602 (Medium)
96-600 (Large)
96-601 (X-large)

Disposable Nitril Gloves

ZF FLUIDS

96-400
Shell Transmission Fluid
 (20 litre container)
 5HP30 w/black tag

NOTE: Do NOT mix SHELL/ESSO during any service.

96-401
Esso Transmission Fluid
 (20 litre container)

5HP30 w/green tag (All other 5 speeds exc. 5HP18 black tag use dexron).
 (NOTE: 5HP18/5HP30 (black tag) can use ESSO for complete rebuild).

TYPE	MAKE	DECAL (color)	PART #	MODELS
5HP18	All	Black	Dexron III - NA	1056-000-092/093 & 088 & lower
		Green	96-401 (Esso)	1056-000-090/091 & 094 & Up
5HP18A	All	Black	Dexron III - NA	1056-020-All
5HP19	All	Green	96-401 (Esso)	1060-000-All
5HP19FL	All	Green	96-401 (Esso)	1060-030-All
5HP19FLA	All	Green	96-401 (Esso)	1060-040-All
5HP19HL	All	Green	96-401 (Esso)	1060-050-All
5HP19HLA	All	Green	96-401 (Esso)	1060-060-All
5HP24	All	Green	96-401 (Esso)	1058-000-All
5HP24A	All	Green	96-401 (Esso)	1058-020-All
5HP30	BMW	Black	96-400 (Shell)	1050-000-007/010/011/015/029/030
	BMW	Green	96-401 (Esso)	1055-000-016/017/019/026/&031 & Up
	Bentley	Green	96-401 (Esso)	1050-000-All
	RR	Green	96-401 (Esso)	1050-000-All